

Varenummer: 0109082
 Beskrivelse: Seeger låsering AS 70X4.0
 Fjederstål
 Note: Monteres med ZGA tang

Mål

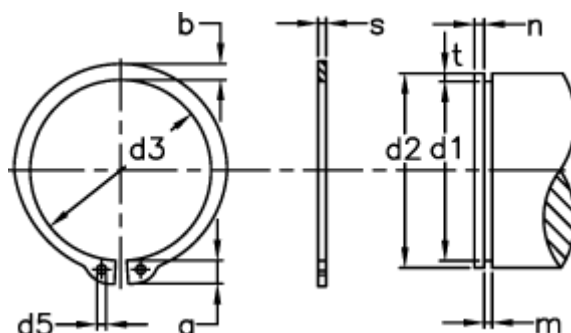

a max	= 9.5	d5 min	= 3.0	s	= 4.00
AN mm ²	= 323.0	FN kN	= 53.80	t	= 1.50
B	= 2.56	FRg kN	= 59.0	Tang	= ZGA-3
b	= 6.6	FR kN	= 343.0	tol	= -0.10
Betegnelse	= AS 70	g	= 2.5	tol	= +0,46 -1,10
d1	= 67.0	m min	= 4.15	tol	= -0.30
d2	= 70	n abl x 1000	= 7	vægt kg/1000	= 32.20
d3	= 65.5	Nominel træk	= 4.5		